

KStrong® BRUTE-AL™ 50 ft. Aluminum Housing Cable SRL with snap hook. Includes installation carabiner and tagline (ANSI).

Model: UFS480050

50' Cable SRL, swivel eye at anchorage end, other end load indicator swivel snap hook. Includes installation carabiner and tagline



DESIGN

- Robust & durable Aluminum casing powder coated
- Has swivel anchorage eye at anchorage end
- Steel swivel hook at retractable end (Our ref. PN 144 as per ANSI Z359.12-2009 gate strength 3600 lbs.)
- Galvanized steel wire rope (option of having S.S. wire rope available)

CABLE

Material: Galvanized steel wire rope Ø3/16"
Minimum Breaking Strength: 3400 lbs.

LENGTH

50 Feet

WEIGHT

15 lbs. ± 0.22 lbs. (6804 gm ±100 gm)

RELEVANT STANDARDS

Meets or Exceeds ANSI Z359.14-2014 Class B



FRONT VIEW

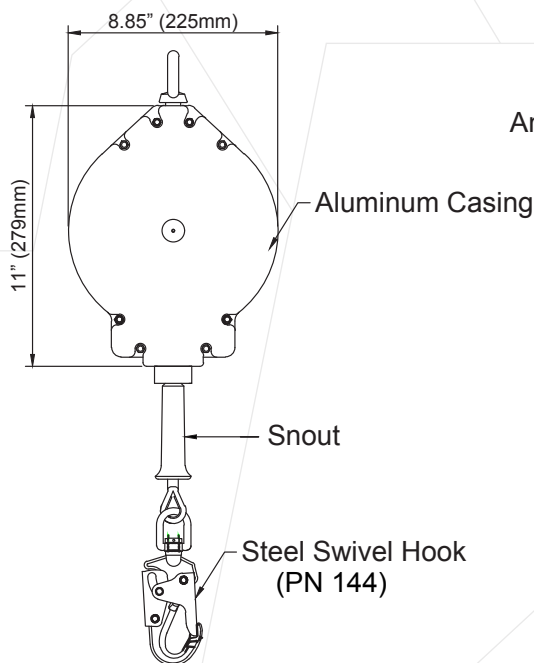

SIDE VIEW

